

Electric Motors

IE2 Motors

Industrial

hoyermotors.com

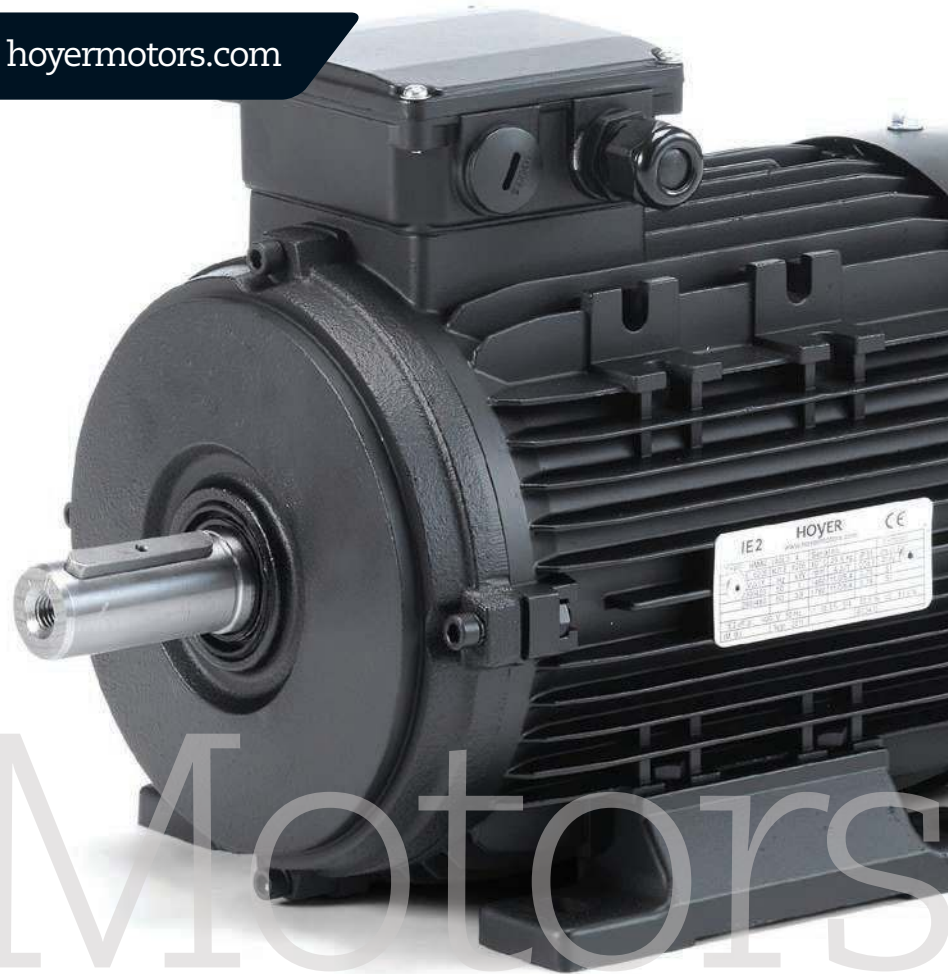

IE2 Motors

HOYER
MOTORS



HOYER

EXCEEDING EXPECTATIONS

Hoyer Motors is an international supplier of high-end electric motors. Headquartered in Denmark and China, we are represented through sales offices and distributors worldwide. We pride ourselves of being an elite manufacturing enterprise with the highest attention to service and flexibility – a company where dedication, competitiveness and reliability are second to none.

We have a selected focus on the segments Marine, Water, HVAC, HPU, Oil & Gas and Wind. Through strong partnerships with market leading industrial OEM's within these segments, we are able to offer a unique setup and industrial insight. We add value by understanding the business and markets of our customers.

At Hoyer Motors, meeting agreements is as natural as breathing air. We believe in trustworthy partnerships with our customers and always meet our obligations on deliveries, documentation and product quality. This is what we mean by Exceeding Expectations.

General information about Hoyer IE2 industrial electric motors

Hoyer IE2 industrial electric motors are manufactured according to international standards under IEC and are fulfilling the requirement of the EC Directive 2005/32 (IE2-directive).

Hoyer motors are installed in many different industrial fields all over the world, and with a proven quality, high reliability and performance, Hoyer is a known brand in the market.

Technical information

Totally enclosed squirrel cage, TEFC, three phase motors type HMA2 (aluminum) in size 56 to 132 (size 160 and 180 on request) and type HMC2 (cast iron) in size 160 to 400 (below size 160 and bigger than size 400 on request).

Rotor is casted with 100% pure aluminum and shaft is made of high quality C45 steel.

HMC2 motors are provided with SKF bearings. HMA2 motors are supplied with C&U bearings. All sizes have fixed bearing in drive-end as standard.

Stator winding is made with double coated copper wire and phase to phase insulation. The insulation system is Class F, maximum 105K temperature rise at 40°C ambient temperature.

Motors below 200kW are designed for Class B temperature rise.

Class H insulation system can be delivered on request.

All motors are manufactured according to IEC 60034, IEC60072, EN50347 and tested according to IEC60034-2-1.

Rotor is dynamically balanced with half key to fulfill vibration level IEC60034-14 grade A.

Sound level within limits of IEC60034-9.

Hoyer IE2 industrial motors \leq 3kW are manufactured for 230/400V 50Hz and $>$ 3kW for 400/690V 50Hz. Other voltages can be supplied on request.

All Hoyer IE2 industrial motors are with PTC terminal protection. Motors can be modified with bimetal detector, heating elements for stand still protection and PT100 for both winding and bearings on request.

Protection is IP55 with shaft sealing as standard. Higher protection class on request.

Motor size \geq 100 are supplied with eyebolts for lifting.

Hoyer IE2 industrial motors are painted black RAL 9005 with low gloss for use in normal industrial environments.

Application info

Hoyer IE2 industrial electric motors are used within a wide variety of applications. Some of the typical applications are listed below:

- Fans (air handling units, refrigeration plants, oil coolers)
- Hydraulic power packs
- Pumps (for water, fuel, oil)
- Shredders (granulation, crushing)
- Gears (gear reducers, gearmotors)



IE2 / 2 pol Industrial

Motor type	Power kw	Speed rpm	Current at 400V		Efficiency (%)			Pf cos φ	Torque			IM J(kg ^m ²)	Weight kg
			I _N (A)	I _g /I _N	1/1 load	3/4 load	1/2 load		T _N	T _g /T _N	T _M /T _N		
Aluminium motors													
HMA2 56 1-2	0,09	2720	0,35	6,0	62	59	55	0,68	0,31	2,3	2,4	0,00010	3,7
HMA2 56 2-2	0,12	2720	0,38	6,0	67	64	60	0,71	0,43	2,3	2,4	0,00012	3,9
HMA2 63 1-2	0,18	2720	0,53	6,0	69	67	64	0,75	0,63	2,2	2,4	0,00013	4,1
HMA2 63 2-2	0,25	2720	0,75	6,0	68	66	63	0,76	0,88	2,2	2,4	0,00015	4,6
HMA2 71 1-2	0,37	2730	0,95	6,0	70	69	67	0,82	1,3	2,2	2,4	0,00044	6,0
HMA2 71 2-2	0,55	2730	1,33	6,0	73	72	70	0,82	1,9	2,2	2,4	0,00055	6,5
HMA2 80 1-2	0,75	2850	1,7	7,5	81,4	81,2	78,3	0,81	2,5	2,5	3,2	0,0011	9,0
HMA2 80 2-2	1,1	2880	2,3	7,7	80,9	79,9	76,1	0,82	3,6	3,2	3,3	0,0013	11
HMA2 90S-2	1,5	2850	3,1	8,4	83,5	83,0	80,2	0,85	4,9	2,9	3,1	0,0018	15
HMA2 90L-2	2,2	2850	4,4	8,5	85,7	85,8	83,9	0,85	7,2	2,9	3,2	0,0022	17
HMA2 100L-2	3,0	2890	5,8	8,7	85,7	85,5	83,4	0,87	9,9	3,1	3,5	0,0043	23
HMA2 112M1-2	4,0	2900	7,5	8,4	87,0	87,1	85,4	0,90	13	3,2	3,4	0,0065	32
HMA2 132S1-2	5,5	2880	10,5	8,4	87,0	86,3	83,6	0,89	18	2,4	3,5	0,015	45
HMA2 132S2-2	7,5	2900	13,5	8,4	88,1	87,6	85,3	0,90	25	2,4	3,5	0,016	51

Cast iron motors													
HMC2 160M1-2	11	2930	20	7,9	89,4	89,3	87,5	0,89	36	2,2	2,3	0,040	123
HMC2 160M2-2	15	2930	27	8,0	90,3	90,3	89,2	0,89	49	2,2	2,3	0,047	132
HMC2 160L-2	18,5	2930	33	8,1	90,9	91,3	90,4	0,89	60	2,2	2,3	0,058	151
HMC2 180M-2	22	2940	39	8,2	91,3	91,1	89,7	0,89	71	2,2	2,3	0,079	203
HMC2 200L1-2	30	2950	53	7,5	92,0	92,2	90,7	0,89	97	2,2	2,3	0,130	246
HMC2 200L2-2	37	2950	65	7,5	92,5	92,7	90,1	0,89	119	2,2	2,3	0,146	256
HMC2 225M-2	45	2960	78	7,6	92,9	92,4	90,5	0,89	145	2,2	2,3	0,246	328
HMC2 225M1-2*	55	2960	96	10,2	93,2	93,1	92,3	0,89	177	2,0	2,3	0,337	355
HMC2 250M-2	55	2970	96	7,6	93,2	92,7	90,8	0,89	177	2,2	2,3	0,328	433
HMC2 250M1-2*	75	2970	130	9,0	93,8	93,7	92,8	0,89	241	2,0	2,3	0,602	433
HMC2 280S-2	75	2970	129	6,9	93,8	93,6	92,5	0,89	240	2,0	2,3	0,627	572
HMC2 280M-2	90	2970	155	7,0	94,1	93,9	92,8	0,89	289	2,0	2,3	0,709	632
HMC2 315S-2	110	2980	187	7,1	94,3	94,0	92,8	0,90	352	2,0	2,2	1,124	850
HMC2 315M-2	132	2980	223	7,1	94,6	94,0	92,8	0,90	425	2,0	2,2	1,91	930
HMC2 315L1-2	160	2980	267	7,1	94,8	94,1	92,9	0,91	513	2,0	2,2	2,18	1020
HMC2 315L2-2	200	2980	334	7,1	95,0	94,1	92,9	0,91	640	2,0	2,2	2,53	1120
HMC2 355M-2	250	2980	417	7,1	95,0	94,9	94,5	0,91	800	2,0	2,2	4,52	1820
HMC2 355L1-2	315	2980	526	7,1	95,0	94,9	94,5	0,91	1010	2,0	2,2	5,35	1850
HMC2 355L2-2	355	2980	590	7,1	95,3	95,3	95,0	0,92	1135	1,8	2,2	5,10	2150
HMC2 400M2-2	400	2980	675	7,1	95,5	95,5	95,2	0,92	1280	1,8	2,2	5,57	2950
HMC2 400M3-2	450	2980	755	7,1	95,5	95,5	95,2	0,92	1430	1,8	2,2	7,05	3200
HMC2 400L1-2	500	2985	830	7,0	95,8	95,8	95,5	0,92	1595	1,8	2,2	7,10	3250
HMC2 400L2-2	560	2985	930	7,0	95,8	95,8	95,5	0,92	1780	1,8	2,2	7,15	3300

Data at 400V 50Hz

At 230V 50Hz the current is $\sqrt{3}$ x current at 400V and at 690V the current is current at 400V / $\sqrt{3}$. All other data are identical.

*Motors with high power / small frame

Motor type	Power kw	Speed rpm	Current at 400V		Efficiency (%)			Pf cos φ	Torque			IM J(kg·m ²)	Weight kg
			I _N (A)	I _g /I _N	1/1 load	3/4 load	1/2 load		T _N	T _g /T _N	T _M /T _N		

Aluminium motors

HMA2 56 1-4	0,06	1380	0,35	6,0	46	43	38	0,58	0,42	2,3	2,4	0,00020	3,5
HMA2 56 2-4	0,09	1380	0,40	6,0	49	46	41	0,55	0,62	2,3	2,4	0,00021	3,7
HMA2 63 1-4	0,12	1350	0,50	6,0	53	50	45	0,63	0,85	2,2	2,4	0,00025	4,0
HMA2 63 2-4	0,18	1340	0,71	6,0	56	53	48	0,62	1,3	2,2	2,4	0,00028	4,2
HMA2 71 1-4	0,25	1390	0,80	6,0	65	62	58	0,68	1,7	2,2	2,4	0,00044	6,0
HMA2 71 2-4	0,37	1380	1,1	6,0	67	64	60	0,73	2,6	2,2	2,4	0,00054	6,4
HMA2 80 1-4	0,55	1370	1,52	6,0	73	72	68	0,73	3,8	2,2	2,4	0,0012	9,5
HMA2 80 2-4	0,75	1420	1,8	5,9	80,8	81,1	78,8	0,78	5,0	2,5	2,6	0,0017	13
HMA2 90S-4	1,1	1420	2,6	5,5	81,5	81,2	79,6	0,73	7,4	2,5	3,2	0,0023	17
HMA2 90L-4	1,5	1450	3,4	6,6	84,4	83,7	80,6	0,71	9,9	2,7	3,4	0,0031	18
HMA2 100L1-4	2,2	1440	4,6	7,3	85,2	84,8	82,3	0,78	14,5	2,5	3,4	0,0078	26
HMA2 100L2-4	3,0	1440	6,1	7,3	86,3	85,9	83,6	0,77	20	2,6	3,4	0,0087	28
HMA2 112M2-4	4,0	1450	7,9	7,1	86,7	86,9	85,2	0,84	26	2,2	2,9	0,019	37
HMA2 132S-4	5,5	1450	11	7,5	88,4	88,1	86,2	0,80	36	2,3	3,3	0,033	51
HMA2 132M1-4	7,5	1460	15	7,3	88,9	89,1	87,9	0,82	49	2,2	3,2	0,041	62

Cast iron motors

HMC2 160M-4	11	1460	21	7,5	89,8	89,7	89,2	0,85	72	2,2	2,3	0,078	123
HMC2 160L-4	15	1460	28	7,5	90,6	90,5	87,9	0,86	98	2,2	2,3	0,096	153
HMC2 180M-4	18,5	1470	34	7,7	91,2	91,7	91,0	0,86	120	2,2	2,3	0,146	204
HMC2 180L-4	22	1470	40	7,8	91,6	91,9	91,3	0,86	143	2,2	2,3	0,166	215
HMC2 200L-4	30	1470	54	7,2	92,3	92,8	91,3	0,86	194	2,2	2,3	0,275	243
HMC2 200L1-4*	37	1470	67	8,3	92,7	92,6	91,5	0,86	240	2,2	2,3	0,483	318
HMC2 225S-4	37	1475	67	7,3	92,7	92,8	90,9	0,86	238	2,2	2,3	0,426	305
HMC2 225M-4	45	1475	81	7,4	93,1	93,1	91,3	0,86	290	2,2	2,3	0,492	328
HMC2 225M1-4*	55	1480	98	9,2	93,5	93,4	92,7	0,87	355	2,2	2,3	0,746	365
HMC2 250M-4	55	1480	99	7,4	93,5	93,8	91,5	0,86	354	2,2	2,3	0,693	452
HMC2 250M1-4*	75	1480	134	9,0	94,0	93,9	93,0	0,86	484	2,2	2,3	1,29	452
HMC2 280S-4	75	1485	130	6,7	94,0	94,2	92,4	0,88	483	2,2	2,3	1,18	592
HMC2 280M-4	90	1485	156	6,9	94,2	94,5	92,7	0,88	580	2,2	2,3	1,53	672
HMC2 280MB-4*	110	1480	194	9,3	94,5	94,4	93,6	0,87	710	2,1	2,2	2,87	672
HMC2 315S-4	110	1485	191	6,9	94,5	94,7	94,7	0,88	705	2,2	2,3	3,27	840
HMC2 315M-4	132	1485	228	6,9	94,7	94,9	94,3	0,88	850	2,2	2,3	3,80	930
HMC2 315L1-4	160	1485	273	6,9	94,9	95,2	94,7	0,89	1030	2,2	2,3	4,34	1000
HMC2 315L2-4	200	1485	341	6,9	95,1	95,3	94,8	0,89	1285	2,2	2,3	5,37	1080
HMC2 315L3-4*	250	1480	425	7,3	95,2	95,3	94,7	0,89	1606	2,2	2,4	6,7	1350
HMC2 355M-4	250	1490	421	6,9	95,1	95,5	94,8	0,90	1610	2,2	2,4	8,51	1650
HMC2 355L-4	315	1490	531	7,0	95,1	95,5	94,8	0,90	2025	2,2	2,4	10,8	1830
HMC2 355LB-4	355	1485	600	7,5	95,3	95,5	95,2	0,92	2285	2,2	2,4	12,4	2170
HMC2 400M1-4	400	1490	690	6,9	95,5	95,6	95,4	0,89	2565	1,4	3,0	14,9	3000
HMC2 400M2-4	450	1490	775	6,9	95,5	95,6	95,5	0,89	2885	1,4	3,0	15,2	3100
HMC2 400L1-4	500	1490	850	7,0	95,6	95,7	95,6	0,89	3200	1,3	3,0	18,5	3200
HMC2 400L2-4	560	1490	945	7,0	96,0	96,0	95,9	0,89	3590	1,4	3,0	19,4	3400
HMC2 400L3-4	630	1490	1110	7,1	96,0	96,1	96,0	0,89	4040	1,5	3,1	21,1	3500

Data at 400V 50Hz

At 230V 50Hz the current is $\sqrt{3}$ x current at 400V and at 690V the current is current at 400V / $\sqrt{3}$. All other data are identical.

*Motors with high power / small frame

IE2 / 6 pol Industrial

Motor type	Power kw	Speed rpm	Current at 400V		Efficiency (%)			Pf cos φ	Torque			IM J(kgm ²)	Weight kg
			I _N (A)	I _g /I _N	1/1 load	3/4 load	1/2 load		T _N	T _g /T _N	T _M /T _N		
Aluminium motors													
HMA2 63 1-6	0,09	830	0,54	6,0	38	34	28	0,67	1,0	2,2	2,4	0,00025	4,0
HMA2 63 2-6	0,12	830	0,61	6,0	40	36	30	0,68	1,3	2,2	2,4	0,00032	4,2
HMA2 71 1-6	0,18	900	0,70	6,0	59	56	52	0,66	1,9	2,2	2,4	0,00044	6,0
HMA2 71 2-6	0,25	920	0,90	6,0	59	56	52	0,68	2,7	2,2	2,4	0,00055	6,5
HMA2 80 1-6	0,37	900	1,25	6,0	62	60	57	0,70	3,9	2,2	2,4	0,0014	10
HMA2 80 2-6	0,55	900	1,75	6,0	65	63	60	0,72	5,8	2,2	2,4	0,0019	12
HMA2 90S-6	0,75	960	1,9	4,5	75,9	74,4	69,6	0,65	7,5	2,1	2,7	0,0032	17,5
HMA2 90L-6	1,1	950	2,7	5,5	80,9	80,8	78,2	0,71	11	2,2	2,9	0,0041	21
HMA2 100L-6	1,5	960	3,6	5,5	80,1	80,1	77,3	0,68	15	2,3	2,6	0,0085	26
HMA2 112M1-6	2,2	960	5,2	5,9	83,6	83,8	81,7	0,71	22	2,3	2,8	0,013	35
HMA2 132S-6	3,0	960	6,9	6,9	85,5	85,4	83,2	0,74	29	2,1	2,8	0,037	46
HMA2 132M1-6	4,0	960	9,1	7,3	85,8	85,3	82,5	0,71	39	2,5	2,9	0,049	61
HMA2 132M2-6	5,5	960	12,5	7,4	87,4	87,2	85,2	0,73	54	2,5	2,9	0,059	66

Cast iron motors													
HMC2 160M-6	7,5	970	16	6,7	87,2	87,1	84,3	0,78	74	2,1	2,3	0,093	123
HMC2 160L-6	11	970	22	6,9	88,7	88,6	85,0	0,79	108	2,1	2,2	0,122	157
HMC2 180L-6	15	970	30	7,2	89,7	89,3	86,7	0,81	146	2,0	2,2	0,217	206
HMC2 200L1-6	18,5	980	36	7,2	90,4	90,5	88,2	0,81	180	2,1	2,2	0,331	243
HMC2 200L2-6	22	980	42	7,3	90,9	90,9	88,5	0,82	214	2,1	2,2	0,378	256
HMC2 225M-6	30	980	58	7,1	91,7	91,7	86,5	0,81	290	2,0	2,1	0,574	306
HMC2 250M-6	37	980	69	7,1	92,2	92,2	88,1	0,84	360	2,1	2,2	0,876	416
HMC2 280S-6	45	980	81	7,2	92,7	92,6	90,2	0,86	440	2,0	2,1	1,46	603
HMC2 280M-6	55	980	99	7,5	93,1	93,1	92,4	0,86	535	2,0	2,1	1,73	693
HMC2 315S-6	75	985	136	6,7	93,7	93,6	92,3	0,85	725	2,0	2,1	4,32	840
HMC2 315M-6	90	985	164	6,7	94,0	94,1	92,6	0,84	870	2,0	2,1	5,02	1020
HMC2 315L1-6	110	985	198	6,7	94,3	94,3	92,9	0,85	1060	2,0	2,1	5,73	1060
HMC2 315L2-6	132	985	234	6,7	94,6	94,6	93,1	0,86	1280	2,0	2,1	6,43	1150
HMC2 355M1-6	160	990	280	6,7	94,8	94,8	93,5	0,87	1545	2,0	2,1	10,9	1540
HMC2 355M2-6	200	990	349	6,7	95,0	95,0	93,8	0,87	1935	2,0	2,0	13,0	1750
HMC2 355L-6	250	990	436	7,3	95,0	95,0	93,8	0,87	2410	2,0	2,0	16,2	1860
HMC2 400M1-6	315	990	545	7,0	95,2	95,2	94,6	0,88	3040	1,9	2,0	18,0	2220
HMC2 400M2-6	355	990	615	7,0	95,3	95,3	94,7	0,88	3420	1,9	2,0	19,5	2500
HMC2 400L-6	400	990	685	7,0	95,8	95,8	95,0	0,88	3860	1,9	2,0	21,8	2900

Data at 400V 50Hz

At 230V 50Hz the current is $\sqrt{3}$ x current at 400V and at 690V the current is current at 400V / $\sqrt{3}$. All other data are identical.

Motor type	Power kw	Speed rpm	Current at 400V		Efficiency (%)			Pf cos φ	Torque			IM J(kgm ²)	Weight kg
			I _N (A)	I _g /I _N	1/1 load	3/4 load	1/2 load		T _N	T _g /T _N	T _M /T _N		
Aluminium motors													
HMA2 71 1-8	0,09	670	0,42	5,5	49	46	52	0,60	1,3	2,2	2,4	0,00044	6
HMA2 71 2-8	0,12	670	0,56	6,0	50	47	43	0,60	1,7	2,2	2,4	0,00055	6,5
HMA2 80 1-8	0,18	680	0,80	6,0	51	48	44	0,61	2,5	2,2	2,4	0,0014	9,5
HMA2 80 2-8	0,25	680	1,06	6,0	54	51	47	0,61	3,5	2,2	2,4	0,0019	12
HMA2 90S-8	0,37	690	1,4	6,0	62	60	57	0,61	5,1	2,2	2,4	0,0027	14
HMA2 90L-8	0,55	690	2,1	6,0	63	61	58	0,61	7,5	2,2	2,4	0,0035	17
HMA2 100L1-8	0,75	700	2,4	6,0	71	70	68	0,67	10	2,2	2,4	0,0067	23
HMA2 100L2-8	1,1	700	3,3	6,0	73	72	70	0,69	15	2,2	2,4	0,0078	26
HMA2 112M1-8	1,5	700	4,5	6,0	75	74	72	0,68	20	2,2	2,4	0,012	34
HMA2 132S-8	2,2	710	5,7	6,0	78	78	76	0,71	30	2,0	2,2	0,022	45
HMA2 132M-8	3,0	710	7,6	5,5	79	79	77	0,73	40	2,0	2,2	0,039	54

Cast iron motors

HMC2 160M1-8	4,0	720	9,8	7,0	81	82	81	0,73	53	1,9	2,0	0,075	118
HMC2 160M2-8	5,5	720	13	7,0	83	84	83	0,74	73	1,9	2,0	0,093	119
HMC2 160L-8	7,5	720	17	7,0	86	87	87	0,75	100	1,9	2,0	0,13	145
HMC2 180L-8	11	730	24	7,0	88	89	88	0,76	144	1,9	2,0	0,20	172
HMC2 200L-8	15	730	33	7,0	88	89	88	0,76	196	1,9	2,0	0,34	236
HMC2 225S-8	18,5	730	39	7,0	90	91	90	0,76	242	1,9	2,0	0,49	292
HMC2 225M-8	22	740	45	7,0	90,5	91,3	90,5	0,78	288	1,9	2,0	0,55	302
HMC2 250M-8	30	740	60	7,0	91,0	91,6	90,8	0,79	390	1,9	2,0	0,83	396
HMC2 280S-8	37	740	74	7,0	91,5	92,0	91,5	0,79	485	1,9	2,0	1,4	520
HMC2 280M-8	45	740	90	7,0	92,0	92,5	92,0	0,79	590	1,9	2,0	1,7	533
HMC2 315S-8	55	740	106	7,0	92,8	93,1	92,9	0,81	715	1,8	2,0	4,8	1125
HMC2 315M-8	75	740	144	7,0	93,0	93,3	93,1	0,81	975	1,8	2,0	5,6	1250
HMC2 315L1-8	90	740	169	7,0	93,8	94,0	93,8	0,82	1170	1,8	2,0	6,4	1310
HMC2 315L2-8	110	740	206	7,0	94,0	94,2	94,0	0,82	1430	1,8	2,0	7,2	1350
HMC2 355M1-8	132	740	248	6,5	94,2	94,3	94,2	0,82	1705	1,8	2,0	11	1750
HMC2 355M2-8	160	740	299	6,5	94,5	94,7	94,6	0,82	2065	1,8	2,0	12	1880
HMC2 355L-8	200	740	368	6,5	95,0	95,1	94,9	0,83	2580	1,8	2,0	13	2060
HMC2 400M1-8	250	745	469	6,5	95,0	95,2	95,1	0,81	3225	1,8	2,0	25	3100
HMC2 400L1-8	315	745	563	6,5	95,0	95,1	95,0	0,85	4040	1,8	2,0	28	3300
HMC2 400L2-8	355	745	658	7,0	95,0	95,1	95,0	0,82	4550	1,8	2,0	30	3400
HMC2 400L3-8	400	745	741	7,0	95,0	95,0	94,9	0,82	5130	1,8	2,0	31	3550

Data at 400V 50Hz

At 230V 50Hz the current is $\sqrt{3}$ x current at 400V and at 690V the current is current at 400V / $\sqrt{3}$. All other data are identical.

IE2 / B3 Industrial

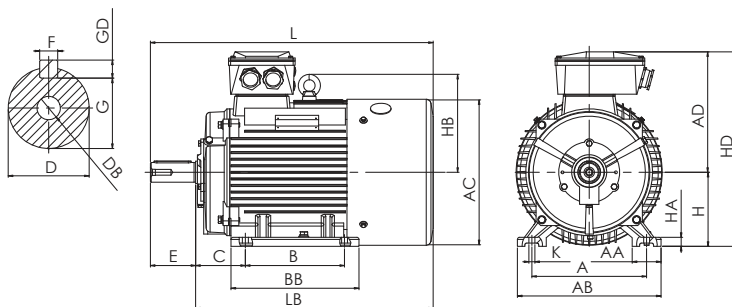

Motor type	Pole	A	AA	AB	AC	AD	B	BB	C	D	DB	E	F	G	GD	H	HA	HB	HD	K	L	LB
------------	------	---	----	----	----	----	---	----	---	---	----	---	---	---	----	---	----	----	----	---	---	----

Aluminum motors

HMA2 56	-	90	20	110	115	100	71	90	36	9	M4	20	3	7,2	3	56	7,5	-	156	5,8	195	175
HMA2 63	-	100	22	125	125	100	80	108	40	11	M4	23	4	8,5	4	63	9	-	163	7	215	192
HMA2 71	-	112	24	140	140	110	90	114	45	14	M5	30	5	11	5	71	9	-	181	7	246	216
HMA2 80	-	125	27	160	158	128	100	122	50	19	M6	40	6	15,5	6	80	12	-	208	10	290	250
HMA2 90S	-	140	35	175	175	132	100	155	56	24	M8	50	8	20	7	90	13	-	222	10	335	285
HMA2 90L	-	140	35	175	175	132	125	155	56	24	M8	50	8	20	7	90	13	-	222	10	361	311
HMA2 100L	-	160	42	205	197	147	140	176	63	28	M10	60	8	24	7	100	12	-	247	12	400	350
HMA2 112M1	-	190	45	222	220	169	140	180	70	28	M10	60	8	24	7	112	13	145	281	12	394	334
HMA2 112M2	-	190	45	222	220	169	140	180	70	28	M10	60	8	24	7	112	13	145	281	12	422	362
HMA2 132S	-	216	50	256	260	188	140	180	89	38	M12	80	10	33	8	132	16,5	165	320	12	462	382
HMA2 132M1	-	216	50	256	260	188	178	218	89	38	M12	80	10	33	8	132	16,5	165	320	12	500	420
HMA2 132M2	-	216	50	256	260	188	178	218	89	38	M12	80	10	33	8	132	16,5	165	320	12	525	445

Cast iron motors

HMC2 160M	-	254	65	320	316	277	210	260	108	42	M16	110	12	37	8	160	20	222	437	14,5	615	505
HMC2 160L	-	254	65	320	316	277	254	305	108	42	M16	110	12	37	8	160	20	222	437	14,5	670	560
HMC2 180M	-	279	70	355	356	297	241	315	121	48	M16	110	14	42,5	9	180	22	237	477	14,5	700	590
HMC2 180L	-	279	70	355	356	297	279	355	121	48	M16	110	14	42,5	9	180	22	237	477	14,5	740	630
HMC2 200L	-	318	70	395	396	321	305	375	133	55	M20	110	16	49	10	200	25	262	521	18,5	770	660
HMC2 200L1*	4,6,8	318	70	388	397	313	305	369	133	55	M20	110	16	46	10	200	25	263	513	18,5	769	660
HMC2 225S	4,6,8	356	75	435	446	346	286	375	149	60	M20	140	18	53	11	225	28	285	571	18,5	815	675
HMC2 225M	2	356	75	435	446	346	311	400	149	55	M20	110	16	49	10	225	28	285	571	18,5	820	710
	4,6,8	356	75	435	446	346	311	400	149	60	M20	140	18	53	11	225	28	285	571	18,5	845	705
HMC2 225M1*	2	356	75	431	463	347	311	393	149	55	M20	110	16	49	10	225	28	572	572	18,5	864	754
	4,6,8	356	75	431	463	347	311	393	149	60	M20	140	18	53	11	225	28	307	572	18,5	864	754
HMC2 250M	2	406	80	490	490	367	349	445	168	60	M20	140	18	53	11	250	30	316	617	24	915	775
	4,6,8	406	80	490	490	367	349	445	168	65	M20	140	18	58	11	250	30	316	617	24	915	775
HMC2 250M1*	2	406	80	484	500	390	349	450	168	60	M20	140	18	53	11	250	30	361	640	24	1015	875
	4,6,8	406	80	484	500	390	349	450	168	65	M20	140	18	58	11	250	30	361	640	24	1015	875
HMC2 280S	2	457	85	550	550	405	368	490	190	65	M20	140	18	58	11	280	35	345	685	24	985	845
	4,6,8	457	85	550	550	405	368	490	190	75	M20	140	20	67,5	12	280	35	345	685	24	985	845
HMC2 280M	2	457	85	550	550	405	419	540	190	65	M20	140	18	58	11	280	35	345	685	24	1035	895
	4,6,8	457	85	550	550	405	419	540	190	75	M20	140	20	67,5	12	280	35	345	685	24	1035	895
HMC2 280MB*	4,6,8	457	85	542	557	419	419	536	190	75	M20	140	20	67,5	12	280	35	417	699	24	1092	952
HMC2 315S	2	508	120	635	620	550	406	575	216	65	M20	140	18	58	11	315	45	430	865	28	1215	1075
	4,6,8	508	120	635	620	550	406	575	216	80	M20	170	22	71	14	315	45	430	865	28	1245	1075
HMC2 315M	2	508	120	635	620	550	457	685	216	65	M20	140	18	58	11	315	45	430	865	28	1325	1185
	4,6,8	508	120	635	620	550	457	685	216	80	M20	170	22	71	14	315	45	430	865	28	1355	1185
HMC2 315L	2	508	120	635	620	550	508	685	216	65	M20	140	18	58	11	315	45	430	865	28	1325	1185
	4,6,8	508	120	635	620	550	508	685	216	80	M20	170	22	71	14	315	45	430	865	28	1355	1185
HMC2 315L3*	4,6,8	508	120	628	620	556	508	680	216	80	M20	170	22	71	14	315	45	442	871	28	1458	1288
HMC2 355M	2	610	116	730	700	671	560	760	254	75	M20	140	20	67,5	12	355	52	490	1065	28	1515	1375
	4,6,8	610	116	730	700	671	560	760	254	95	M24	170	25	86	14	355	52	490	1065	28	1545	1375
HMC2 355L	2	610	116	730	700	671	630	760	254	75	M20	140	20	67,5	12	355	52	490	1065	28	1515	1375
	4,6,8	610	116	730	700	671	630	760	254	95	M24	170	25	86	14	355	52	490	1065	28	1545	1375
HMC2 400M	2	686	120	806	856	690	630	1090	280	80	M20	170	22	71	14	400	45	610	1090	35	1880	1710
	4,6,8	686	120	806	856	690	630	1090	280	110	M24	210	28	100	16	400	45	610	1090	35	1920	1710
HMC2 400L	2	686	120	806	856	690	710	1090	280	80	M20	170	22	71	14	400	45	610	1090	35	1880	1710
	4,6,8	686	120	806	856	690	710	1090	280	110	M24	210	28	100	16	400	45	610	1090	35	1920	1710

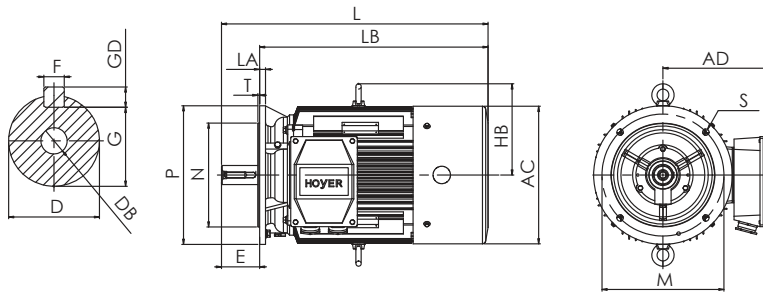

IE2 / B5
Industrial

Motor type	Pole	AC	AD	D	DB	E	F	G	GD	HB	L	LA	LB	M	N	P	S	T
------------	------	----	----	---	----	---	---	---	----	----	---	----	----	---	---	---	---	---

Aluminum motors

HMA2 56	-	115	100	9	M4	20	3	7,2	3	-	195	7	175	100	80	120	4-Ø7	3
HMA2 63	-	125	100	11	M4	23	4	8,5	4	-	215	9	192	115	95	140	4-Ø10	3
HMA2 71	-	140	110	14	M5	30	5	11	5	-	246	10	216	130	110	160	4-Ø10	3,5
HMA2 80	-	158	128	19	M6	40	6	15,5	6	-	290	10	250	165	130	200	4-Ø12	3,5
HMA2 90S	-	175	132	24	M8	50	8	20	7	-	335	10	285	165	130	200	4-Ø12	3,5
HMA2 90L	-	175	132	24	M8	50	8	20	7	-	361	10	311	165	130	200	4-Ø12	3,5
HMA2 100L	-	197	147	28	M10	60	8	24	7	-	400	14	350	215	180	250	4-Ø15	4
HMA2 112M1	-	220	169	28	M10	60	8	24	7	145	394	14	334	215	180	250	4-Ø15	4
HMA2 112M2	-	220	169	28	M10	60	8	24	7	145	422	14	362	215	180	250	4-Ø15	4
HMA2 132S	-	260	188	38	M12	80	10	33	8	165	462	15	382	265	230	300	4-Ø15	4
HMA2 132M1	-	260	188	38	M12	80	10	33	8	165	500	15	420	265	230	300	4-Ø15	4
HMA2 132M2	-	260	188	38	M12	80	10	33	8	165	525	15	445	265	230	300	4-Ø15	4

Cast iron motors

HMC2 160M	-	316	277	42	M16	110	12	37	8	222	615	18	505	300	250	350	4-Ø18,5	5
HMC2 160L	-	316	277	42	M16	110	12	37	8	222	670	18	560	300	250	350	4-Ø18,5	5
HMC2 180M	-	356	297	48	M16	110	14	42,5	9	237	700	18	590	300	250	350	4-Ø18,5	5
HMC2 180L	-	356	297	48	M16	110	14	42,5	9	237	740	20	630	300	250	350	4-Ø18,5	5
HMC2 200L	-	396	321	55	M20	110	16	49	10	262	770	20	660	350	300	400	4-Ø18,5	5
HMC2 200L1*	4,6,8	397	313	55	M20	110	16	49	10	263	769	17	660	350	300	400	4-Ø18,5	5
HMC2 225S	4,6,8	446	346	60	M20	140	18	53	11	285	815	22	675	400	350	450	8-Ø18,5	5
HMC2 225M	2	446	346	55	M20	110	16	49	10	285	820	22	710	400	350	450	8-Ø18,5	5
	4,6,8	446	346	60	M20	140	18	53	11	285	845	22	705	400	350	450	8-Ø18,5	5
HMC2 225M1*	2	463	347	55	M20	110	16	49	10	307	864	20	754	400	350	450	8-Ø18,5	5
	4,6,8	463	347	60	M20	140	18	53	11	307	864	20	754	400	350	450	8-Ø18,5	5
HMC2 250M	2	490	367	60	M20	140	18	53	11	316	915	24	775	500	450	550	8-Ø18,5	5
	4,6,8	490	367	65	M20	140	18	58	11	316	915	24	775	500	450	550	8-Ø18,5	5
HMC2 250M1*	2	500	390	60	M20	140	18	53	11	361	1015	22	875	500	450	550	8-Ø18,5	5
	4,6,8	500	390	65	M20	140	18	58	11	361	1015	22	875	500	450	550	8-Ø18,5	5
HMC2 280S	2	550	405	65	M20	140	18	58	11	345	985	24	845	500	450	550	8-Ø18,5	5
	4,6,8	550	405	75	M20	140	20	67,5	12	345	985	24	845	500	450	550	8-Ø18,5	5
HMC2 280M	2	550	405	65	M20	140	18	58	11	345	1035	24	895	500	450	550	8-Ø18,5	5
	4,6,8	550	405	75	M20	140	20	67,5	12	345	1035	24	895	500	450	550	8-Ø18,5	5
HMC2 280MB*	4,6,8	557	419	75	M20	140	20	67,5	12	417	1092	22	952	500	450	550	8-Ø18,5	5
HMC2 315S	2	620	550	65	M20	140	18	58	11	430	1215	24	1075	600	550	660	8-Ø24	6
	4,6,8	620	550	80	M20	170	22	71	14	430	1245	24	1075	600	550	660	8-Ø24	6
HMC2 315M	2	620	550	65	M20	140	18	58	11	430	1325	24	1185	600	550	660	8-Ø24	6
	4,6,8	620	550	80	M20	170	22	71	14	430	1355	24	1185	600	550	660	8-Ø24	6
HMC2 315L	2	620	550	65	M20	140	18	58	11	430	1325	24	1185	600	550	660	8-Ø24	6
	4,6,8	620	550	80	M20	170	22	71	14	430	1355	24	1185	600	550	660	8-Ø24	6
HMC2 315L3*	4,6,8	620	556	80	M20	170	22	71	14	442	1458	22	1288	600	550	660	8-Ø24	6
HMC2 355M	2	700	671	75	M20	140	20	67,5	12	490	1515	25	1375	740	680	800	8-Ø24	6
	4,6,8	700	671	95	M24	170	25	86	14	490	1545	25	1375	740	680	800	8-Ø24	6
HMC2 355L	2	700	671	75	M20	140	20	67,5	12	490	1515	25	1375	740	680	800	8-Ø24	6
	4,6,8	700	671	95	M24	170	25	86	14	490	1545	25	1375	740	680	800	8-Ø24	6
HMC2 400M	2	856	690	80	M20	170	22	71	14	610	1880	25	1710	940	880	1000	8-Ø28	6
	4,6,8	856	690	110	M24	210	28	100	16	610	1920	25	1710	940	880	1000	8-Ø28	6
HMC2 400L	2	856	690	80	M20	170	22	71	14	610	1880	25	1710	940	880	1000	8-Ø28	6
	4,6,8	856	690	110	M24	210	28	100	16	610	1920	25	1710	940	880	1000	8-Ø28	6

*Motors with high power / small frame

IE2 / B14 Industrial

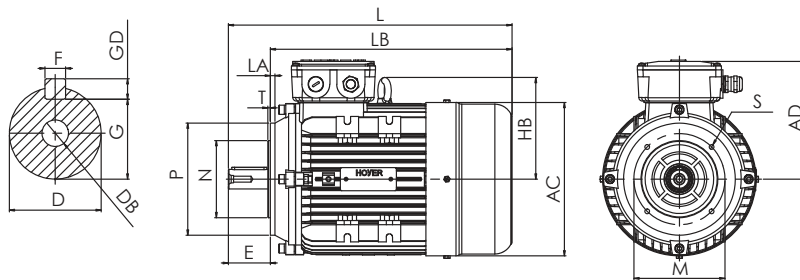

Motor type	AC	AD	D	DB	E	F	G	GD	HB	L	LB	B14A small or C DIN flange					B14B big				
												M	N	P	S	T	M	N	P	S	T

Aluminum motors

HMA2 56	115	100	9	M4	20	3	7,2	3	-	195	175	65	50	80	4-M5	2,5	-	-	-	-	-
HMA2 63	125	100	11	M4	23	4	8,5	4	-	215	192	75	60	90	4-M5	2,3	-	-	-	-	-
HMA2 71	140	110	14	M5	30	5	11	5	-	246	216	85	70	105	4-M6	2,5	115	95	140	4-M8	3
HMA2 80	158	128	19	M6	40	6	15,5	6	-	290	250	100	80	120	4-M6	3	130	110	160	4-M8	3,5
HMA2 90S	175	132	24	M8	50	8	20	7	-	335	285	115	95	140	4-M8	3	130	110	160	4-M8	3,5
HMA2 90L	175	132	24	M8	50	8	20	7	-	361	311	115	95	140	4-M8	3	130	110	160	4-M8	3,5
HMA2 100L	197	147	28	M10	60	8	24	7	-	400	350	130	110	160	4-M8	3,5	165	130	200	4-M10	4
HMA2 112M1	220	169	28	M10	60	8	24	7	145	394	334	130	110	160	4-M8	3,5	165	130	200	4-M10	4
HMA2 112M2	220	169	28	M10	60	8	24	7	145	422	362	130	110	160	4-M8	3,5	165	130	200	4-M10	4
HMA2 132S	260	188	38	M12	80	10	33	8	165	462	382	165	130	200	4-M10	4	-	-	-	-	-
HMA2 132M1	260	188	38	M12	80	10	33	8	165	500	420	165	130	200	4-M10	4	-	-	-	-	-
HMA2 132M2	260	188	38	M12	80	10	33	8	165	500	420	165	130	200	4-M10	4	-	-	-	-	-

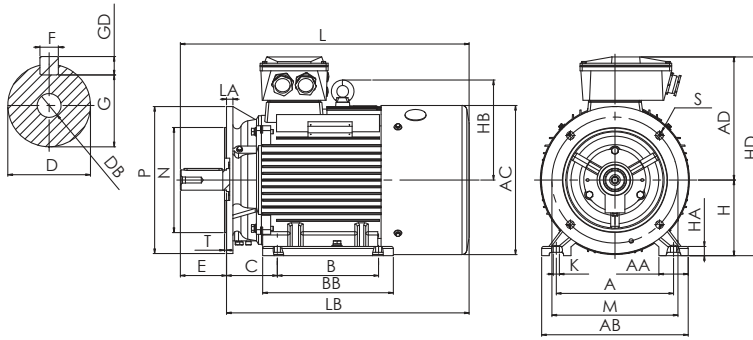

IE2 / B35
Industrial

Motor type	Pole	A	AA	AB	AC	AD	B	BB	C	D	DB	E	F	G	GD	H	HA	HB	HD	K	L	LA	LB	M	N	P	S	T
------------	------	---	----	----	----	----	---	----	---	---	----	---	---	---	----	---	----	----	----	---	---	----	----	---	---	---	---	---

Aluminum motors

HMA2 56	-	90	20	110	115	100	71	90	36	9	M4	20	3	7,2	3	56	7,5	-	156	5,8	195	7	175	100	80	120	4-Ø7	3
HMA2 63	-	100	22	125	125	100	80	108	40	11	M4	23	4	8,5	4	63	9	-	163	7	215	9	192	115	95	140	4-Ø10	3
HMA2 71	-	112	24	140	140	110	90	114	45	14	M5	30	5	11	5	71	9	-	181	7	246	10	216	130	110	160	4-Ø10	3,5
HMA2 80	-	125	27	160	158	128	100	122	50	19	M6	40	6	15,5	6	80	12	-	208	10	290	10	250	165	130	200	4-Ø12	3,5
HMA2 90S	-	140	35	175	175	132	100	155	56	24	M8	50	8	20	7	90	13	-	222	10	335	10	285	165	130	200	4-Ø12	3,5
HMA2 90L	-	140	35	175	175	132	125	155	56	24	M8	50	8	20	7	90	13	-	222	10	361	10	311	165	130	200	4-Ø12	3,5
HMA2 100L	-	160	42	205	197	147	140	176	63	28	M10	60	8	24	7	100	12	-	247	12	400	14	350	215	180	250	4-Ø15	4
HMA2 112M1	-	190	45	222	220	169	140	180	70	28	M10	60	8	24	7	112	13	145	281	12	394	14	334	215	180	250	4-Ø15	4
HMA2 112M2	-	190	45	222	220	169	140	180	70	28	M10	60	8	24	7	112	13	145	281	12	422	14	362	215	180	250	4-Ø15	4
HMA2 132S	-	216	50	256	260	188	140	180	89	38	M12	80	10	33	8	132	16,5	165	320	12	462	15	382	265	230	300	4-Ø15	4
HMA2 132M1	-	216	50	256	260	188	178	218	89	38	M12	80	10	33	8	132	16,5	165	320	12	500	15	420	265	230	300	4-Ø15	4
HMA2 132M2	-	216	50	256	260	188	178	218	89	38	M12	80	10	33	8	132	16,5	165	320	12	525	15	445	265	230	300	4-Ø15	4

Cast iron motors

HMC2 160M	-	254	65	320	316	277	210	260	108	42	M16	110	12	37	8	160	20	222	437	14,5	615	18	505	300	250	350	4-Ø18,5	5
HMC2 160L	-	254	65	320	316	277	254	305	108	42	M16	110	12	37	8	160	20	222	437	14,5	670	18	560	300	250	350	4-Ø18,5	5
HMC2 180M	-	279	70	355	356	297	241	315	121	48	M16	110	14	42,5	9	180	22	237	477	14,5	700	18	590	300	250	350	4-Ø18,5	5
HMC2 180L	-	279	70	355	356	297	279	355	121	48	M16	110	14	42,5	9	180	22	237	477	14,5	740	20	630	300	250	350	4-Ø18,5	5
HMC2 200L	-	318	70	395	396	321	305	375	133	55	M20	110	16	49	10	200	25	262	521	18,5	770	20	660	350	300	400	4-Ø18,5	5
HMC2 200L1*	4,6,8	318	70	388	397	313	305	369	133	55	M20	110	16	49	10	200	25	263	513	18,5	769	17	660	350	300	400	4-Ø18,5	5
HMC2 225M1*	2	356	75	431	463	347	311	393	149	55	M20	110	16	49	10	225	28	307	572	18,5	864	20	754	400	350	450	8-Ø18,5	5
	4,6,8	356	75	431	463	347	311	393	149	60	M20	140	18	53	11	225	28	307	572	18,5	864	20	754	400	350	450	8-Ø18,5	5
HMC2 225S	4,6,8	356	75	435	446	346	286	375	149	60	M20	140	18	53	11	225	28	285	571	18,5	815	22	675	400	350	450	8-Ø18,5	5
HMC2 250M	2	406	80	490	490	367	349	445	168	60	M20	140	18	53	11	250	30	316	617	24	915	24	775	500	450	550	8-Ø18,5	5
	4,6,8	406	80	490	490	367	349	445	168	65	M20	140	18	58	11	250	30	316	617	24	915	24	775	500	450	550	8-Ø18,5	5
HMC2 250M1*	2	406	80	484	500	390	349	450	168	60	M20	140	18	53	11	250	30	361	640	24	1015	22	875	500	450	550	8-Ø18,5	5
	4,6,8	406	80	484	500	390	349	450	168	65	M20	140	18	58	11	250	30	361	640	24	1015	22	875	500	450	550	8-Ø18,5	5
HMC2 280S	2	457	85	550	550	405	368	490	190	65	M20	140	18	58	11	280	35	345	685	24	985	24	845	500	450	550	8-Ø18,5	5
	4,6,8	457	85	550	550	405	368	490	190	75	M20	140	20	67,5	12	280	35	345	685	24	985	24	845	500	450	550	8-Ø18,5	5
HMC2 280M	2	457	85	550	550	405	419	540	190	65	M20	140	18	58	11	280	35	345	685	24	1035	24	895	500	450	550	8-Ø18,5	5
	4,6,8	457	85	550	550	405	419	540	190	75	M20	140	20	67,5	12	280	35	345	685	24	1035	24	895	500	450	550	8-Ø18,5	5
HMC2 280MB*	4,6,8	457	85	542	557	419	419	536	190	75	M20	140	20	67,5	12	280	35	417	699	24	1092	22	952	500	450	550	8-Ø18,5	5
HMC2 315S	2	508	120	635	620	550	406	575	216	65	M20	140	18	58	11	315	45	430	865	28	1215	24	1075	600	550	660	8-Ø24	6
	4,6,8	508	120	635	620	550	406	575	216	80	M20	170	22	71	14	315	45	430	865	28	1245	24	1075	600	550	660	8-Ø24	6
HMC2 315M	2	508	120	635	620	550	457	685	216	65	M20	140	18	58	11	315	45	430	865	28	1325	24	1185	600	550	660	8-Ø24	6
	4,6,8	508	120	635	620	550	457	685	216	80	M20	170	22	71	14	315	45	430	865	28	1355	24	1185	600	550	660	8-Ø24	6
HMC2 315L	2	508	120	635	620	550	508	685	216	65	M20	140	18	58	11	315	45	430	865	28	1325	24	1185	600	550	660	8-Ø24	6
	4,6,8	508	120	635	620	550	508	685	216	80	M20	170	22	71	14	315	45	430	865	28	1355	24	1185	600	550	660	8-Ø24	6
HMC2 315L3*	4,6,8	508	120	628	620	556	508	680	216	80	M20	170	22	71	14	315	45	442	871	28	1458	22	1288	600	550	660	8-Ø24	6
HMC2 355M	2	610	116	730	700	671	560	760	254	75	M20	140	20	67,5	12	355	52	490	1065	28	1515	25	1375	740	680	800	8-Ø24	6
	4,6,8	610	116	730	700	671	560	760	254	95	M24	170	25	86	14	355	52	490	1065	28	1545	25	1375	740	680	800	8-Ø24	6
HMC2 355L	2	610	116	730	700	671	630	760	254	75	M20	140	20	67,5	12	355	52	490	1065	28	1515	25	1375	740	680	800	8-Ø24	6
	4,6,8	610	116	730	700	671	630	760	254	95	M24	170	25	86	14	355	52	490	1065	28	1545	25	1375	740	680	800	8-Ø24	6
HMC2 400M	2	686	120	806	856	690	630	1090	280	80	M20	170	22	71	14	400	45	610	1090	35	1880	25	1710	940	880	1000	8-Ø28	6
	4,6,8	686	120	806	856	690	630	1090	280	110	M24	210	28	100	16	400	45	610	1090	35	1920	25	1710	940	880	1000	8-Ø28	6
HMC2 400L	2	686	120	806	856	690	710	1090	280	80	M20	170	22	71	14	400	45	610	1090	35	1880	25	1710	940	880	1000	8-Ø28	6
	4,6,8	686	120	806	856	690	710	1090	280	110	M24	210	28	100	16	400	45	610	1090	35	1920	25	1710	940	880	1000	8-Ø28	6

*Motors with high power / small frame

Bearings and Cable Glands

Bearings

Motor type	Drive end		None drive end	
	2 pole	4,6,8 pole	2 pole	4,6,8 pole
HMA2 56	6201-ZZ/C3		6201-ZZ/C3	
HMA2 63	6201-ZZ/C3		6201-ZZ/C3	
HMA2 71	6202-ZZ/C3		6202-ZZ/C3	
HMA2 80	6204-ZZ/C3		6204-ZZ/C3	
HMA2 90	6205-ZZ/C3		6204-ZZ/C3	
HMA2 100	6206-ZZ/C3		6206-ZZ/C3	
HMA2 112	6306-ZZ/C3		6306-ZZ/C3	
HMA2 132	6308-ZZ/C3		6308-ZZ/C3	

HMC2 160	6309-ZZ/C3		6309-ZZ/C3	
HMC2 180	6311-ZZ/C3		6311-ZZ/C3	
HMC2 200	6312-ZZ/C3		6312-ZZ/C3	
HMC2 200L1*		6212-ZZ/C3		6212-ZZ/C3
HMC2 225	6312-ZZ/C3	6313-ZZ/C3		6312-ZZ/C3
HMC2 225M1*	6313-ZZ/C3	6314-ZZ/C3		6313-ZZ/C3
HMC2 250	6313/C3	6314/C3		6313/C3
HMC2 250M1*	6314/C3	6315/C3		6314/C3
HMC2 280	6314/C3	6317/C3		6314/C3
HMC2 280MB*		6317/C3		6317/C3
HMC2 315	6317/C3	NU319/C3 (B3) 6319/C3 (B5/B35)	6317/C3	6319/C3
HMC2 315L3*		NU319 (B3) 6319/C3 (B5/B35)		6319/C3
HMC2 355	6319/C3	NU322/C3 (B3) 6322/C3 (B5/B35)	6319/C3	6322/C3
HMC2 400	6322/C3	6326/C3	6322/C3	6326/C3

*Motors with high power / small frame

Cable glands

Motor type	Cable glands	Blind caps
HMA2 56	1 x M20x1,5	1 x M20x1,5
HMA2 63	1 x M20x1,5	1 x M20x1,5
HMA2 71	1 x M20x1,5	1 x M20x1,5
HMA2 80	1 x M20x1,5	1 x M20x1,5
HMA2 90	1 x M20x1,5	1 x M20x1,5
HMA2 100	1 x M20x1,5	1 x M20x1,5
HMA2 112	1 x M20x1,5	1 x M20x1,5
HMA2 132	2 x M25x1,5	1 x M20x1,5

HMC2 160	2 x M40x1,5	2 x M20x1,5
HMC2 180	2 x M40x1,5	2 x M20x1,5
HMC2 200	2 x M50x1,5	2 x M20x1,5
HMC2 225	2 x M50x1,5	2 x M20x1,5
HMC2 250	2 x M63x1,5	2 x M20x1,5
HMC2 280	2 x M63x1,5	2 x M20x1,5
HMC2 315	2 x M63x1,5	2 x M20x1,5
HMC2 355	2 x M72x2,0	2 x M20x1,5
HMC2 400	2 x M80x2,0	2 x M20x1,5

Rating plate

IE2		HOYER		CE	
www.hoyermotors.com					
Type: HMC2 280M-4		Serial No: SH984762-123		3~Motor	
D.E. 6317	N.D.E 6314		668Kg	IP55	Ins.cl. F
V. Δ / Y	Hz	KW	rpm	A. Δ / Y	Cos φ
400/690	50	90	1480	156/90	0,88
Δ 380	50	87,3	1480	Δ 162	0,88
Δ 440	60	104	1775	Δ 166	0,88
IE2 eff. at: 400/690V 50Hz		1/1: 94.2%		3/4: 94.5%	1/2: 92.7%
IM: B5	Year: 2012	Tropical windings		IEC 60034-1	

Rating table amb. temp.

Amb. temp.	30°C	35°C	40°C	45°C	50°C	55°C	60°C
P/P _N	1,05	1,02	1,00	0,97	0,93	0,87	0,82

Workshop and Extras

Workshop

In combination with the wide-ranging stock our highly skilled and certified workshop secures the most flexible stock in the business. Among other things the options for rebuild includes:

- Anti condensation heating
- ATEX Zone 22 / 2 (ExnA)
- Special bearings
- SPM nipples
- Forced fan cooling
- Pt100 built in thermo sensors
- Balancing class "A" or "B" (IEC60034-14)
- IP56, IP65 and IP66
- TENV (IC410) for mounting on open deck
- Encoders



Extras

Due to the shared facilities with Hoyer Transmissions we are able to provide an unique combination of extras:

- Pulleys
- Taper locks
- Belts
- Motor slides and rails
- Couplings
- Locking elements



Mounting Positions

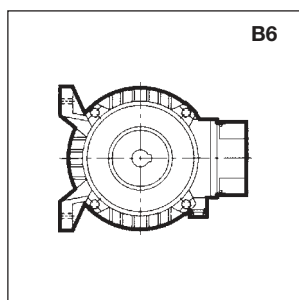

B6

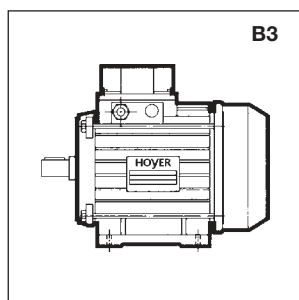

B3

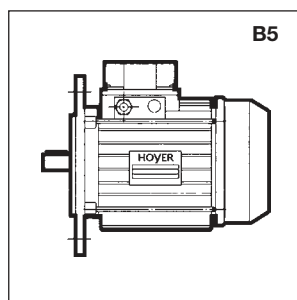

B5

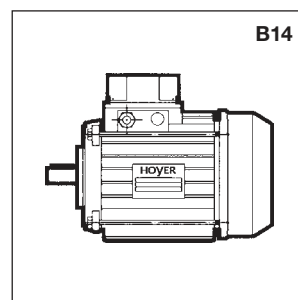

B14

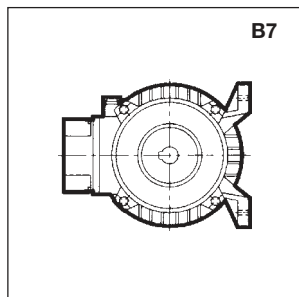

B7

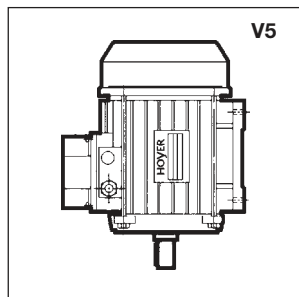

V5

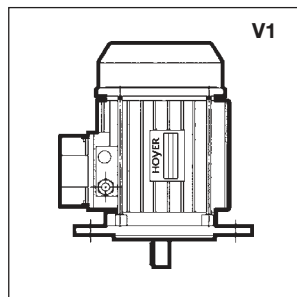

V1

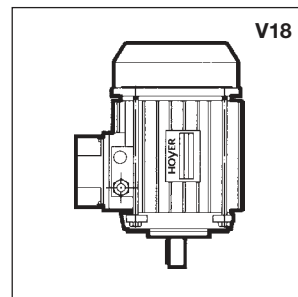

V18

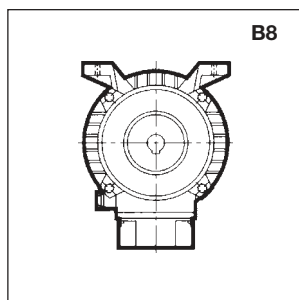

B8

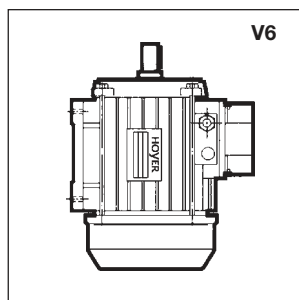

V6

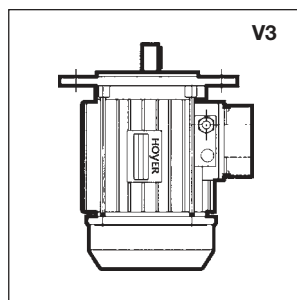

V3

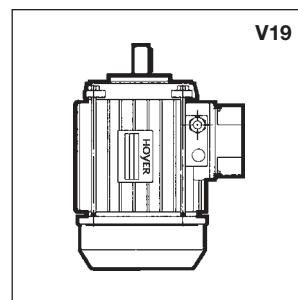

V19

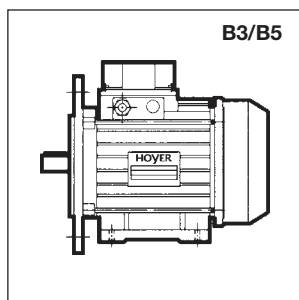

B3/B5

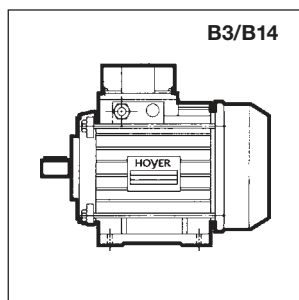

B3/B14

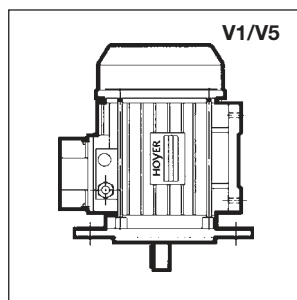

V1/V5

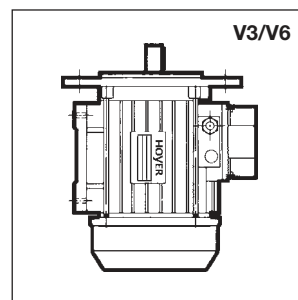

V3/V6

*Important notice: V3 mounting with standard housing only accepted up to frame size 250. Motors frame size 280 and up need special housing and flange.